

Datasheet SFC5500 mass flow controller and SFM5500 mass flow meter

Datasheet – V3

- Excellent accuracy and repeatability (0.8% / 0.1% of setpoint respectively)
- Very wide control and measurement range (<0.1% - 100% full scale)
- G ¼" flange compatible with a broad range of connectors: e.g. Swagelok, Legris, Festo
- Calibrated for multiple gases (Air, N₂, O₂, H₂, He, CH₄, N₂O, Ar, CO₂)
- Digital interface with temperature-compensated output
- Ultra-fast settling time (<100 ms)
- Pressure resistance up to 10 bar
- Mean Time Between Failures (MTBF) 169 years
- No drift and no re-calibration required in the field
- NIST-traceable calibration
- EK-F5x evaluation kit for quick and easy testing

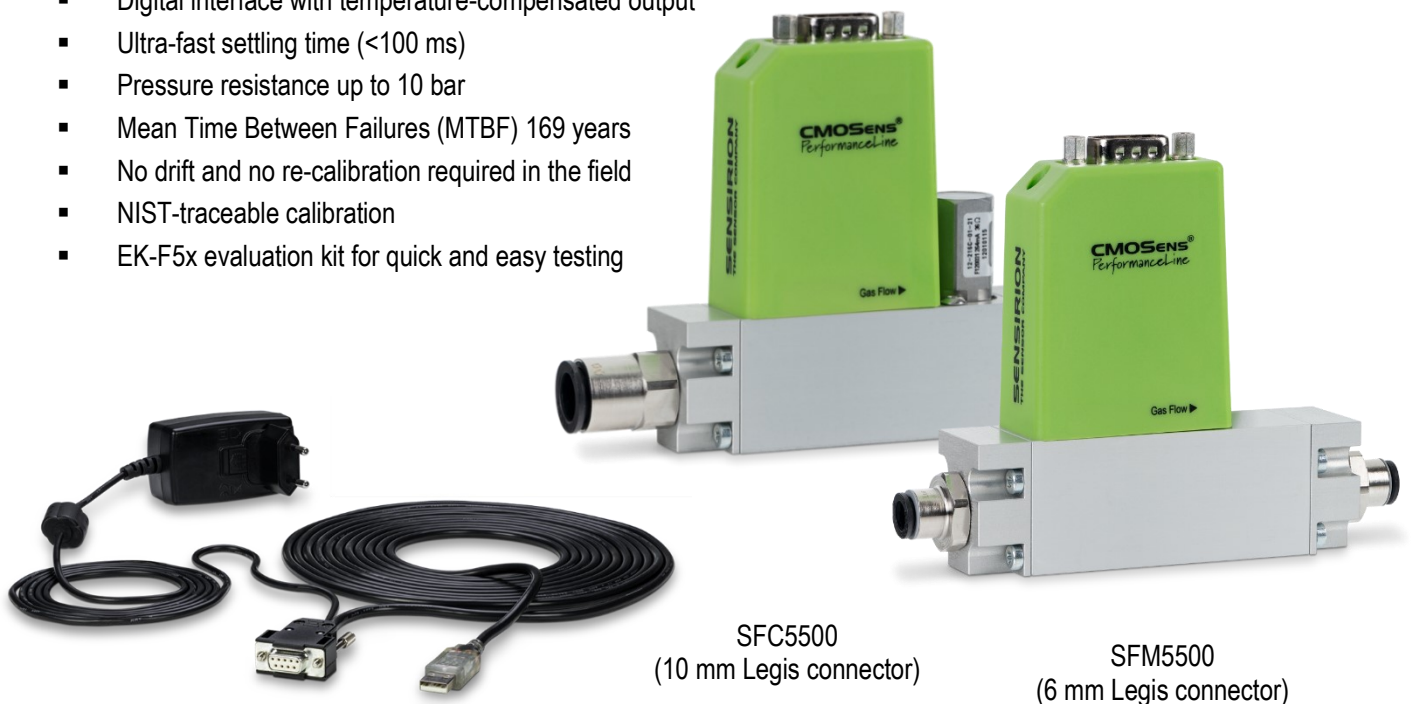

SFC5500
(10 mm Legris connector)

SFM5500
(6 mm Legris connector)

EK-F5x Evaluation Kit for SFC5500 and SFM5500

Unsurpassed CMOSens® Technology

The heart of SFC5500 and SFM5500 products is the unsurpassed Sensirion CMOSens® technology. It combines a high precision sensor element with state-of-the-art signal processing on a single chip and thereby providing an accurately calibrated and temperature compensated signal (Figure 1). Thanks to this sensor technology, SFC5500 and SFM5500 achieve unmatched ratings for speed, accuracy and repeatability at very attractive system cost. Due to the excellent long-term stability of CMOSens® chips, no recalibration is required.

The SFC5500 offers ultra-fast settling time and high control range. SFC5500 and SFM5500 are factory calibrated for multiple gases and combine smart features such as gas recognition and self-test capability. Finally,

they offer high flexibility regarding mechanical connectors, which can be exchanged with off-the-shelf components.

The brilliant performance of SFC5500 and SFM5500 products make them the best choice for a wide range of applications, such as analytical instrumentation, coating/etching equipment, medical equipment, process automation and gas mixing to name a few.

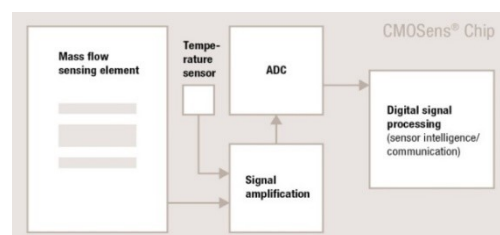

Figure 1: CMOSens® flow sensor diagram.

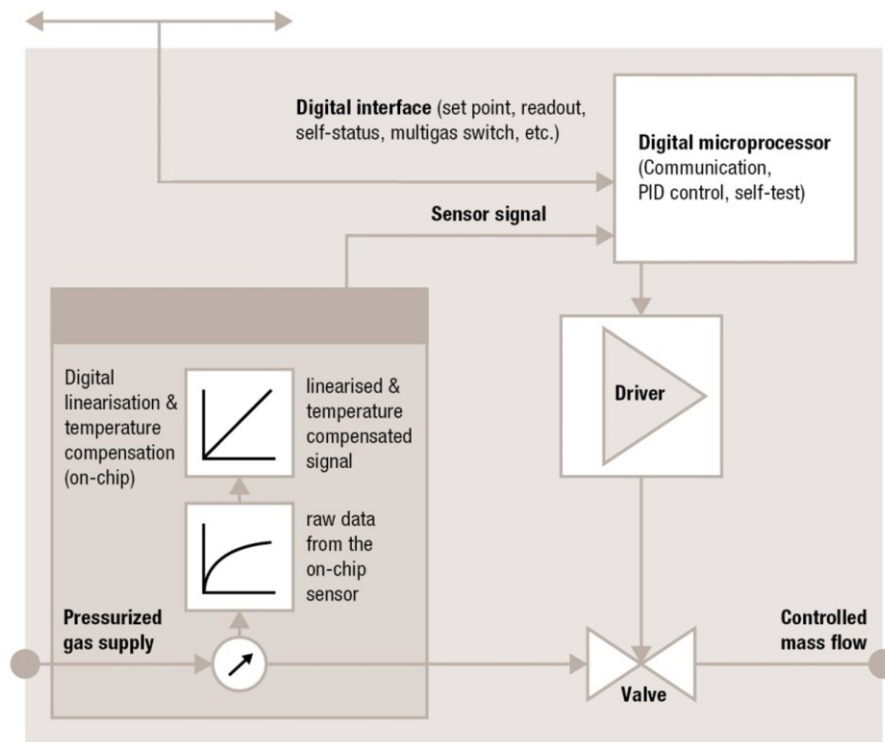

Figure 2: Block diagram CMOSens® SFC5500 mass flow controller.

Introductory Description

CMOSens® SFC5500 and SFM5500 measure gas mass flow by the calorimetric principle based on heat transfer. A heater element on a thermally insulated membrane and two thermopiles up-stream and downstream are integrated on a single silicon chip. In the presence of gas flow, the temperature distribution up- and downstream is disturbed. This asymmetry is then measured. The measurement area as well as the A/D-converter and further signal processing are based on a single chip using CMOS standard processes (see Figure 3).

MEMS-based CMOSens® technology enables a larger cross section (about 1.5x1 mm²) of the gas channel than bypass capillary diameter in conventional mass flow controllers (0.1 to 0.5 mm). This channel design makes the device more robust against particles, clogging and humidified gases. Due to the compact single-chip design and its mounting between metal parts, CMOSens®-based sensors are very resistant to electromagnetic disturbances (EMC).

The minimal thermal mass of the membrane results in an ultra-fast sensor response time of 3-4 ms. Since the whole design of the amplification, A/D conversion, digital linearization and temperature compensation is matched to the sensor speed, a fully compensated flow

measurement value can be delivered every millisecond. Combined with advanced control algorithms running on the on-board microprocessor, SFC5500 offers greatly reduced settling times compared to conventional mass flow controllers (see Figure 2).

Furthermore, a special arrangement of the two temperature sensors, on-chip temperature compensation and the minimization of noise sources lead to unbeatable performance with regards to repeatability and accuracy over a large dynamic range. Thanks to its flawless design, the SFC5500 mass flow controllers and SFM5500 mass flow meters show zero-drift performance and control true mass flow independently of the ambient temperature and pressure changes.

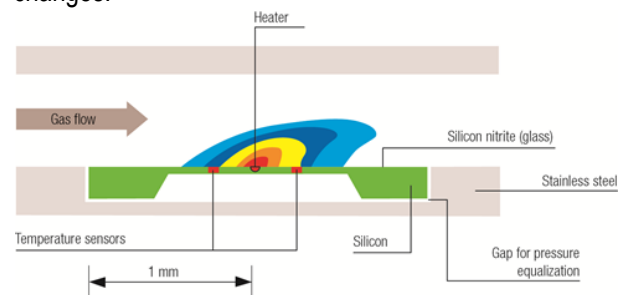

Figure 3: Cross-sectional view of gas channel.

1 CMOSens® SFC5500 / SFM5500 mass flow controller / meter performance

Table 1: Overview of CMOSens® SFC5500 Mass Flow Controllers and SFM5500 Mass Flow Meters

X stands for C=controller, or M=Meter. All data, unless otherwise noted, apply for the following calibration conditions: horizontal mounting position (el. connector on top), downmount connection, temperature 20°C, Nitrogen (N₂), 3.0 bar overpressure (inlet: 4.0 bar absolute) against atmosphere (outlet: 1.0 bar absolute) for SFC5500 and <0.2 bar overpressure for SFM5500.

Specification		Air & N ₂ *	O ₂	H ₂	He*	CH ₄	N ₂ O	Ar	CO ₂ *
Calibration address		0 (default)	1	2	3	4	5	6	7
Full scale flow [sccm]	SFX5500-50sccm	50	50	200	200	50	50	50	50
Accuracy ¹ whichever is greater	[% s.p.] ²	2	3	4	2	4	4	4	2
	[% FS] ³	0.2	0.3	0.4	0.2	0.4	0.4	0.4	0.2
Repeatability whichever is greater	[% s.p.]	0.2							
	[% FS]	0.02							
Full scale flow [slm]	SFX5500-0.5slm	0.5	0.5	2.0	2.0	0.5	0.2	0.2	0.2
	SFX5500-2slm	2.0	2.0	5.0	5.0	2.0	1.0	1.0	1.0
	SFX5500-10slm	10	10	10	10	10	5.0	5.0	5.0
Accuracy whichever is greater	[% s.p.]	0.80	2.0	3.0	0.80	3.0	3.0	3.0	0.8
	[% FS]	0.08	0.20	0.30	0.08	0.30	0.30	0.30	0.08
Repeatability whichever is greater	[% s.p.]	0.10							
	[% FS]	0.01							
Full scale flow [slm]	SFC5500-200slm	200	160	not calibrated					
Accuracy ⁴ whichever is greater	[% s.p.]	1.0	2.0	not defined					
	[% FS]	0.10	0.20						
Repeatability ⁵ whichever is greater	[% s.p.]	0.2							
	[% FS]	0.02							
Specification	Flow range					Unit			
	50 sccm	0.5 slm	2 slm	10 slm	200 slm				
Typical setting time (SFC only) ⁶	< 100					ms			
Measurement frequency	1000					Hz			
Control / measurement range (SFC / SFM)	<0.1% - 100% full scale (1000:1)								
Operating temp. (ambient & gas)	0 – 50 / 32 – 122					°C / °F			
Temp. coeff. Zero	0.005					% FS / °C			
Temp. coeff. Span	0.06					% s.p. / °C			
Warming up time ⁷	1					s			
Pressure drop at full flow N ₂ / Air (SFC)	< 0.1 / 1	< 0.7 / 11	< 0.1 / 1	< 1.4 / 21	< 4.9 / 72	bar / psig			
Pressure drop at full flow N ₂ / Air (SFM)	< 0.1 / 1	< 0.1 / 1	< 0.1 / 1	< 0.1 / 1	n/a	bar / psig			
Maximum input pressure ⁸	10 / 145					bar / psig			
Maximum differential pressure ⁹	5 / 73 (SFC), 10 / 145 (SFM)					bar / psig			
Leakage external (open valve) ¹⁰	9 x 10 ⁻⁹				9 x 10 ⁻⁶	mbar l/s He			
Leakage through closed valve (SFC)	1 x 10 ⁻⁶					mbar l/s He			
Mounted fittings	Legris OD 6 mm				Legris OD 10 mm				
Flange	G 1/4" threading. Exchangeable fittings								
Interface	Digital: RS 485, IO-Link, DeviceNet								
Flow units	sccm					slm			

* Air, He and CO₂ are calibration gasses. Calibration for Air and N₂ is identical. The calibration of the remaining gasses is a model.

¹ Including offset, non-linearity and hysteresis. Measured against NIST-traceable reference

² in % of set point (s.p.) = measured value (m.v.) = rate = reading value

³ in % of Full Scale (FS) flow

⁴ Valid until 100 slm setpoint. Accuracy deteriorates slightly in 100-200 slm region.

⁵ Valid until 100 slm setpoint. Repeatability deteriorates slightly in 100-200 slm region.

⁶ Step answer from 10% to 100% of full scale within ±5% of setpoint.

⁷ to within ±2 % of setpoint

⁸ Pressure between flow inlet and ambient

⁹ Pressure between flow inlet and flow outlet. For availability of higher differential pressure option, contact Sensirion

¹⁰ External leak integrity measured with Swagelock connectors. It is not guaranteed with push-in connectors such as Legris

1.1 Gas calibration

SFC5500 and SFM55000 are factory-calibrated for multiple gasses. Table 1 lists the available calibrations and the calibration addresses saved in internal memory of the MFC. The desired calibration can be selected by the user. Please see the application notes describing the different interfaces, quick start guide or the Evaluation Kit documentation for instructions on how to activate a desired calibration. These can be found on www.sensirion.com/sfc5500.

Please note that the maximum flow rate achievable with each MFC is strongly dependent on the gas measured. Table 1 lists the maximum flow rates for all gasses for which the products have been calibrated.

The calibration for Air and N₂ is identical. It can be used with both gasses with the same result.

1.2 Accuracy

Accuracy describes how precisely the mass flow controller / meter is able to control / measure flow rate with respect to the real flow of a given gas. Accuracy is mostly determined by the quality of the calibration and can be different for each calibration gas.

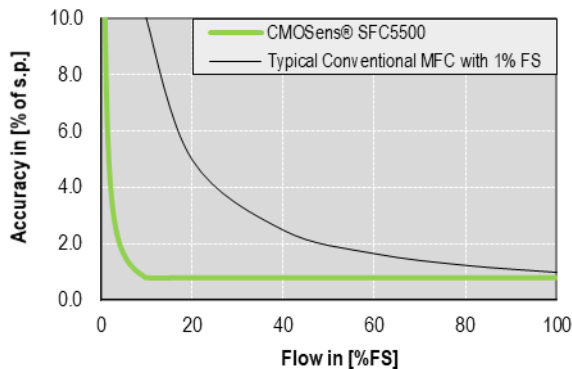

Figure 4: Accuracy comparison of the CMOSens® SFC5500 device compared to a typical thermal mass flow controller.

For example: with mass flow controller set point of 10 slm and a real flow rate measured by an external reference of 10.08 slm, the set point accuracy would be calculated as:

$$Accuracy = \frac{10.08 - 10}{10.08} = 0.8\%$$

Figure 4 compares the set point accuracy of a conventional mass flow controller with a CMOSens® SFC5500. Typically, an accuracy of 1% full scale (FS) is stated for mass flow controllers using conventional sensor technology. Especially at low flow rates the CMOSens® technology reaches superior performance.

1.3 Repeatability

Unlike accuracy, repeatability is not influenced by calibration quality and is directly related to the build quality of the mass flow controller / meter. It describes how reliably mass flow controller is able to reach a given setpoint (applied repeatably). For mass flow meter, it describes, how reliably the instrument measures the same flow repeatably.

For example: if a mass flow meter measures real flow of 10 slm multiple times and the resulting flow measurement results follow a Gaussian distribution centered around 9.97 slm with 0.01 standard deviation, then the repeatability can be calculated as:

$$Repeatability = \frac{0.01}{9.97} = 0.1\%$$

Generally, for mass flow controllers / meters repeatability is better than accuracy. For mass flow controllers, in applications where an additional calibration or feedback loop exists, it is possible to relay on repeatability rather than accuracy of mass flow controller. One example would be an optimized process, where the setpoint value of mass flow controller is fine-tuned to give the desired outcome. In such case, it is not important that the actual flow is close to the set point flow – instead it is important that the optimized set point can be achieved repeatably.

CMOSens® SFC5500 shows a superior performance compared to conventional mass flow controllers with typical repeatability of 0.2% full scale (FS) (Figure 5).

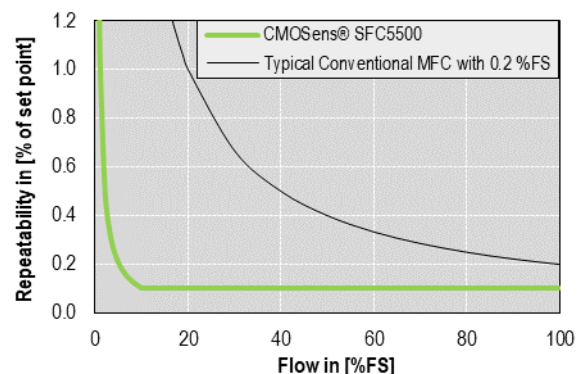

Figure 5: Repeatability comparison of the CMOSens® SFC5500 device compared to a typical thermal mass flow controller.

Accuracy and repeatability at high flows are limited by set point error and at lower end – by the full scale error. Figure 6 demonstrates this.

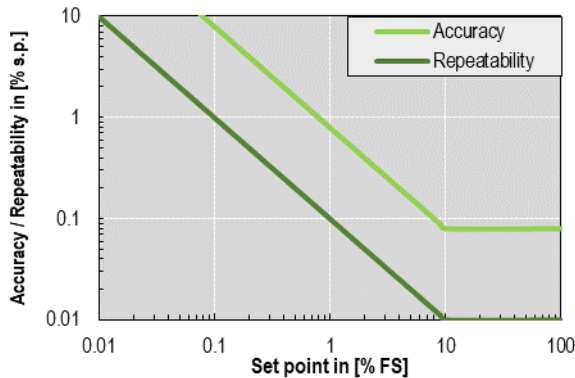

Figure 6 Accuracy and repeatability at different set points.

1.4 Settling time

The CMOSens® SFC5500 mass flow controller has an ultra-fast settling time. Figure 7 shows the typical response time of the SFC5500 in comparison to a mass flow controller using conventional sensor technology.

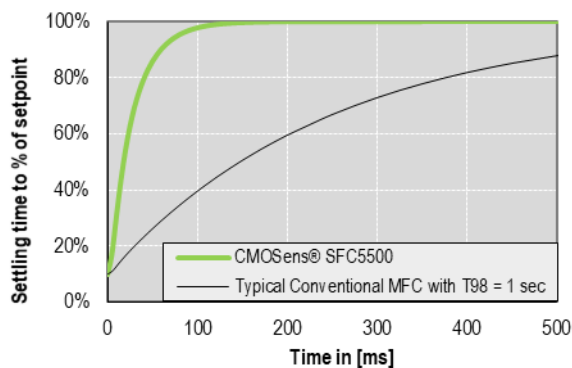

Figure 7: Settling time of the SFC5500 vs. typical thermal mass flow controller.

1.5 Wide control and measurement range

Ultra-wide control range of the SFC5500 brings a decisive benefit in applications with a wide dynamic range of gas flows. Instead of two devices used for high flow and low flow ranges, a single SFC5500 device can efficiently cover a flow range of three orders of magnitude.

Control and measurement range is defined as <0.1% - 100% full scale. This means that a mass flow controller with e.g. 10 slm full scale flow, can control flows lower than 0.01 slm.

1.6 Pressure drop

Mass flow controllers need pressurized gas sourced to operate. Pressure drop is generated, when gas passes through a mass flow controller. When evaluating a mass flow controller, it is important to verify that at maximum required flow rate, for a given gas the pressure drop will be smaller than the inlet pressure – otherwise the desired maximum flow rate will not be possible to achieve.

Mass flow meters have generally much lower pressure drop due to the absence of the valve and hence this is rarely a practical problem.

Figure 8 shows the maximum achievable flow for different variants of SFC5500 as a function of pressure drop. %FS refers to the percentage of the Full Scale flow defined for Air/N₂.

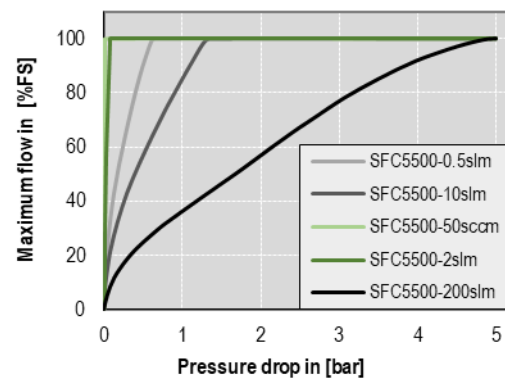

Figure 8 Maximum achievable flow rate at different pressure drops.

At the same setpoint, for gasses heavier than air, the pressure drop would generally be higher. For gasses lighter than air – it would be lower.

1.7 Gas recognition

SFC5500 and SFM5500 employ gas recognition functionality, which can be implemented by the user to display an alert when an activated calibration does not match the gas in line. For further explanation, please see documentation at www.sensirion.com/sfc5500.

2 Construction details

2.1 Fittings

SFC5500 and SFM5500 are designed with a universal G ¼ flange, which enables an easy exchange of fittings (Figure 9). While these instruments are factory-fitted with Legris connectors, the user can easily exchange the fittings by themselves. This does not impact the performance of the device. Any fittings compatible with G ¼" flange can be installed. For an example list of compatible fittings, please see the application note on www.sensirion.com/sfc5500.

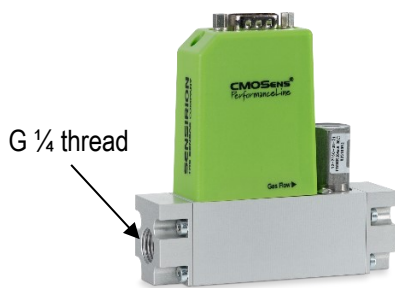

Figure 9: SFC5500 with the fittings removed

2.2 Packaging principle and sealing

To guarantee a vacuum-proof housing of the sensor and the flow path, several patented technologies are used. The CMOSens® chip itself is placed vacuum-tight in a stainless steel package that is connected via O-ring sealing to the aluminum body. The packaging allows SFC5500 and SFM5500 to operate under high input pressure (10 bar / 145 psi) between gas input and ambient (not same as maximum 5 bar / 73 psi between gas input/output for mass flow controllers!).

The electrical connection from the chip to the main controller board uses vacuum-tight glass feed through pins. This packaging method ensures high reliability and tightness for all kinds of gases (see Figure 10).

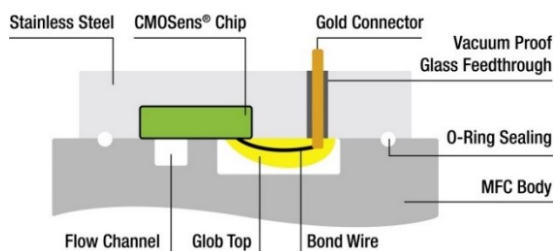

Figure 10: Vacuum-tight glass feed through (longitudinal view)

2.3 Wetted materials & compatibility

The packaging method ensures that a minimum number of inert materials are wetted by the media. Table 2 gives an overview of the materials wetted by the gas. For high volume OEM applications different specialized materials for the body, valve and sealing can be used with sister variants, SFC5400 / SFM5500 or SFC5300 / SFM5300.

Table 2: Overview of Wetted Materials.

Part	Wetted Material
Body	Aluminum
Sensor element	Silicon (Si) Silicon oxide (SiOx) Silicon nitride (Si ₃ N ₄) Stainless steel Glass Glob top
Sealing	FKM
Valve (SFC only)	Brass, FKM

2.4 Safety instructions

2.4.1 Toxic gases

The whole gas assembly must be checked for leakage before applying toxic gas to the device.

2.4.2 Aggressive or corrosive gases

Please make sure that the gases used are compatible with the wetted materials listed in this chapter. In case of doubt, please contact Sensirion for further advice. Corrosive gasses can damage the sealing or the CMOSens® chip.

2.4.3 Explosive gases

The maximum heating energy of the sensor is limited to 12 mW. The CMOSens® sensor element is tested according to EN 50020 chapter 6.2.4 b). Sensirion guarantees the safe use of gases of the classes T1 or T2 (ignition temperature < 300 °C). This includes also mixtures of air or oxygen with hydrogen or hydrocarbons. However, SFC5500 and SFM5500 are not designed for the use in hazardous areas (EN 60079-10) where explosive gases can occur outside of the device.

3 Electrical and communication specifications

3.1 Connector and pin layout

SFC5500 and SFM5500 feature the following digital communication interfaces:

- RS485
- DeviceNet
- IO-Link

Detailed specification of RS485 protocol can be found at www.sensirion.com/sfc5500. The default address of SFC5500 and SFM5500 is "0".

DeviceNet and IO-Link protocols require a larger implementation effort and should be considered only in the context of OEM projects.

The electrical connector of the SFC5500 and SFM5500 is a standard HD Sub-D 9pin. This enables an easy and reliable universal connection. See the pin layout in Figure 11. **Attention: Do not connect PIN 9, as this might damage the controller.**

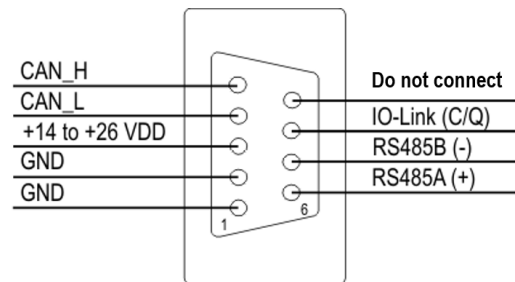

Figure 11: Pinout of the digital interface (RS485, DeviceNet and IO-Link).

3.2 Power supply

The SFC5500 /SFM5500 mass flow controllers / meters require a standard voltage supply of +15.0 to +24.0 VDC. There are no stringent requirements for voltage ripple and stability because of the internal voltage regulation.

3.3 Electrical specifications

Table 3: Electrical characteristics

Parameter	Conditions	Units
Supply Voltage Range (VDD)	Typ. 15.0 – 24.0 Max. 14.0 – 26.4	VDC
Electrical Connector	Sub-D 9pin (male on device)	
PIN 9	Do not connect	-

Table 4: Current consumption

Parameter	Conditions	Typical value (within +/- 5%)		Units
		50 sccm, 0.5 slm, 2 slm	10 slm, 200 slm	
Max. Supply Current (SFC)	VDD = 15 / 24 VDC	180 / 110	320 / 200	mA
Max. Supply Current (SFM)	VDD = 15 / 24 VDC	50 / 35		ma
Standby current	VDD = 15 / 24 VDC	50 / 35		mA

Table 5: Electromagnetic compatibility

Parameter	Hall mark	Notes	Applied values
Electromagnetic Compatibility / Immunity in Industrial Environment: (EN 61000-6-2)	EN 61000-4-2	Air discharge (ESD)	± 8 kV (air) ± 4 kV (contact)
	EN 61000-4-6	High frequency electromagnetic radiation (HF)	10 V _{eff}
	EN 61000-4-4	Fast transients (burst)	± 4 kV

4 Physical dimensions and mounting information for SFC5500 and SFM5500

Physical dimensions and mounting information for SFC5500 and SFM5500 are provided in Figure 12 and Figure 13. All drawings are generated from 3D models available at www.sensirion.com/sfc5500.

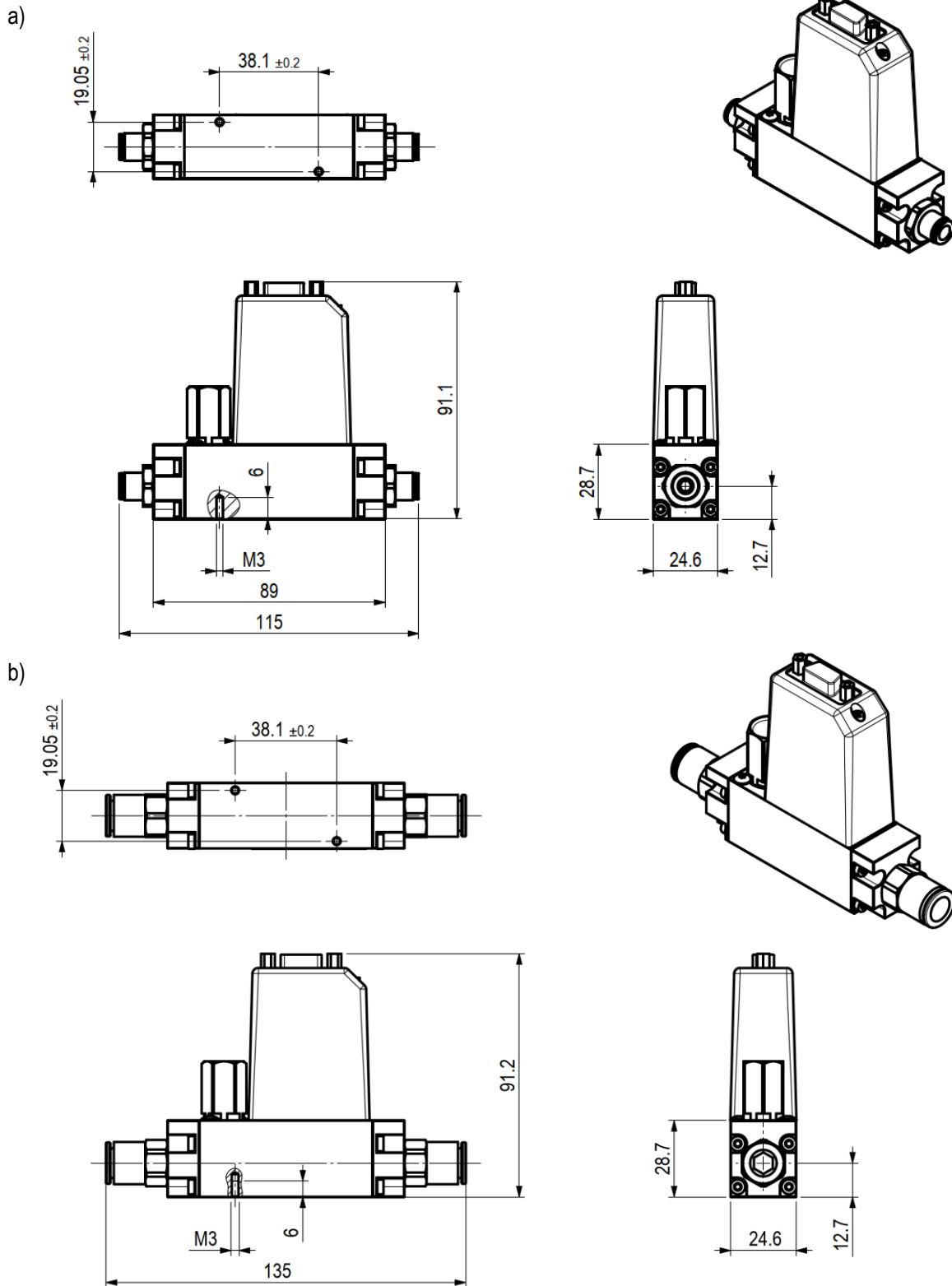

Figure 12: Physical dimensions and mounting information for SFC5500 fitted with a) 6 mm, b) 10 mm Legris connectors. All units are in [mm].

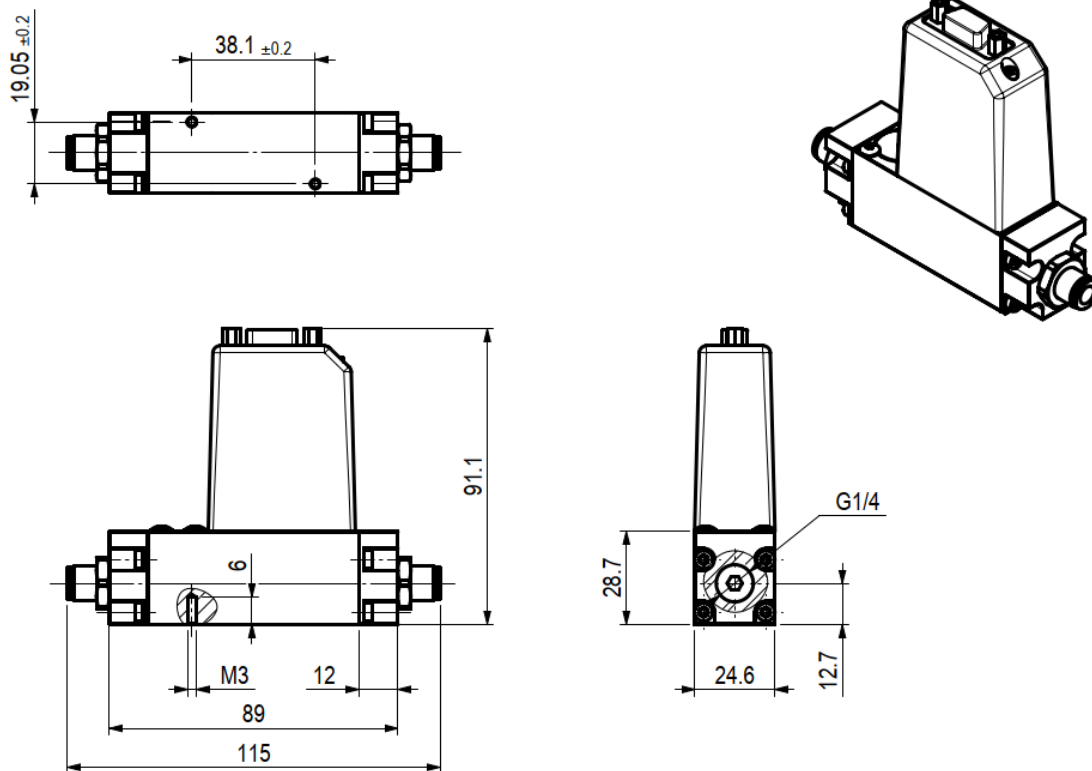

Figure 13 Physical dimensions and mounting information for SFM5500 fitted with 6 mm LEgris connectors. All units are in [mm].

Table 6: Weight

Parameter	Value		Units
	SFC5500	SFM5500	
Mechanical			
Weight (Legris 6 mm OD)	270	240	g
Weight (Legris 10 mm OD)	290	n/a	g
Weight (without fittings)	250	220	g

5 Flow units

SFC5500 / SFM5500 mass flow controllers / meters are calibrated in slm (standard liter per minute) or sccc (standard centimeter cube per minute) units. Please note the difference between “standard” and “norm” units – both are widely used. The differences between those are highlighted in Table 7.

Table 7: Units for gas flow rates

Typical flow unit	Reference condition	
	Gas Temperature	Gas Pressure
slm (standard liter per minute)	20 °C / 68° F	1013 mbar / 14.69 psi
sccc (standard cubic centimeter per minute)		
ln/min (norm liter per minute)	0 °C / 32° F	
mln/min (norm milliliter per minute)		

Example: Relationship between:

slm (20°C / 68°F, 1013 mbar)	and	ln/min (0°C / 32°F, 1013 mbar)
1 slm	=	0.932 ln/min
100 sccm	=	93.2 mln/min

This relationship is gas independent. The 0.932 factor can be used for any gas.

6 OEM options

SFC5500 / SFM5500 mass flow controllers / meters are all special versions of Sensirion's SFC5400 and SFM5400 platform. The only difference is a slightly longer flanges of SFC5500 / SFM5500 to allow for exchangeable fittings. In case SFC5500 / SFM5500 does not meet exactly the requirements for a given application, Sensirion recommends looking at SFC5400 / SFM5400 mass flow controllers / meters, which are available with a variety of configurations (fittings, flow ranges, calibrations, interfaces) and are generally built on order. SFC5400 / SFM5400 and SFC5300 / SFM5300 also allow for OEM product development in the context of high-volume projects. Below, a few OEM options are listed. Please do not hesitate to contact Sensirion AG to discuss your requirements.

Example OEM options for hardware (different wetted materials):

- Stainless steel body or other materials
- Sealing materials (e.g. EPDM / FFKM)
- Valve materials: Stainless steel, EPDM / FFKM on request
- Analog voltage or analog current communication interfaces

OEM options for calibration:

- Multigas calibration (allows switching between a set of gas calibrations saved in the device memory)
- New gas calibrations

7 Ordering codes

Table 8: Products in SFC5500 and SFM5500 series

Article	Description	Article number
SFC5500-50sccm	Digital mass flow controller 50 – 0.05 sccm flow range	3.000.738
SFC5500-0.5slm	Digital mass flow controller 0.5 - 0.0005 slm flow range	3.000.547
SFC5500-2slm	Digital mass flow controller 2 - 0.002 slm flow range	3.000.739
SFC5500-10slm	Digital mass flow controller 10 - 0.01 slm flow range	3.000.548
SFC5500-200slm	Digital mass flow controller 200 - 0.2 slm flow range	3.000.549
SFM5500-50sccm	Digital mass flow meter 50 – 0.05 sccm flow range	3.000.740
SFM5500-0.5slm	Digital mass flow meter 0.5 – 0.005 slm flow range	3.000.741
SFM5500-2slm	Digital mass flow meter 2 - 0.002 slm flow range	3.000.742
SFM5500-10slm	Digital mass flow meter 10 - 0.01 slm flow range	3.000.743
EK-F5x	Plug'n'play evaluation kit (without mass flow meter / controller)	1-101006-01

8 Revision history

Date	Version	Page(s)	Changes
April 2021	1	All	First version
August 2021	2	5, 7	Revised wording in section 1.6, corrected connector to "DB9 male"
April 2022	3	all	Added additional configurations including mass flow meters

Important Notices

Warning, Personal Injury

Do not use this product as safety or emergency stop devices or in any other application where failure of the product could result in personal injury. Do not use this product for applications other than its intended and authorized use. Before installing, handling, using or servicing this product, please consult the data sheet and application notes. Failure to comply with these instructions could result in death or serious injury.

If the Buyer shall purchase or use SENSIRION products for any unintended or unauthorized application, Buyer shall defend, indemnify and hold harmless SENSIRION and its officers, employees, subsidiaries, affiliates and distributors against all claims, costs, damages and expenses, and reasonable attorney fees arising out of, directly or indirectly, any claim of personal injury or death associated with such unintended or unauthorized use, even if SENSIRION shall be allegedly negligent with respect to the design or the manufacture of the product.

ESD Precautions

The inherent design of this component causes it to be sensitive to electrostatic discharge (ESD). To prevent ESD-induced damage and/or degradation, take customary and statutory ESD precautions when handling this product. See application note "ESD, Latchup and EMC" for more information.

Warranty

SENSIRION warrants solely to the original purchaser of this product for a period of 12 months (one year) from the date of delivery that this product shall be of the quality, material and workmanship defined in SENSIRION's published specifications of the product. Within such period, if proven to be defective, SENSIRION shall repair and/or replace this product, in SENSIRION's discretion, free of charge to the Buyer, provided that:

- notice in writing describing the defects shall be given to SENSIRION within fourteen (14) days after their appearance;
- such defects shall be found, to SENSIRION's reasonable satisfaction, to have arisen from SENSIRION's faulty design, material, or workmanship;
- the defective product shall be returned to SENSIRION's factory at the Buyer's expense; and
- the warranty period for any repaired or replaced product shall be limited to the unexpired portion of the original period.

This warranty does not apply to any equipment which has not been installed and used within the specifications recommended by SENSIRION for the intended and proper use of the equipment. EXCEPT FOR THE WARRANTIES EXPRESSLY SET FORTH HEREIN, SENSIRION MAKES NO WARRANTIES, EITHER EXPRESS OR IMPLIED, WITH RESPECT TO THE PRODUCT. ANY AND ALL WARRANTIES, INCLUDING WITHOUT LIMITATION, WARRANTIES OF MERCHANTABILITY OR FITNESS FOR A PARTICULAR PURPOSE, ARE EXPRESSLY EXCLUDED AND DECLINED.

SENSIRION is only liable for defects of this product arising under the conditions of operation provided for in the data sheet and proper use of the goods. SENSIRION explicitly disclaims all warranties, express or implied, for any period during which the goods are operated or stored not in accordance with the technical specifications.

SENSIRION does not assume any liability arising out of any application or use of any product or circuit and specifically disclaims any and all liability, including without limitation consequential or incidental damages. All operating parameters, including without limitation recommended parameters, must be validated for each customer's applications by customer's technical experts. Recommended parameters can and do vary in different applications.

SENSIRION reserves the right, without further notice, (i) to change the product specifications and/or the information in this document and (ii) to improve reliability, functions and design of this product.

Copyright © 2022, by SENSIRION. CMOSens® is a trademark of Sensirion. All rights reserved

Headquarters and Subsidiaries

Sensirion AG

Laubisruetistr. 50
CH-8712 Staefa ZH
Switzerland

phone: +41 44 306 40 00
fax: +41 44 306 40 30
info@sensirion.com
www.sensirion.com

Sensirion Taiwan Co. Ltd

phone: +886 3 5506701
info@sensirion.com
www.sensirion.com

Sensirion Inc., USA

phone: +1 312 690 5858
info-us@sensirion.com
www.sensirion.com

Sensirion Japan Co. Ltd.

phone: +81 3 3444 4940
info-jp@sensirion.com
www.sensirion.com/jp

Sensirion Korea Co. Ltd.

phone: +82 31 337 7700~3
info-kr@sensirion.com
www.sensirion.com/kr

Sensirion China Co. Ltd.

phone: +86 755 8252 1501
info-cn@sensirion.com
www.sensirion.com/cn

To find your local representative, please visit www.sensirion.com/distributors

FCC and CE statement

The SFC5500 products have been tested and found to comply with the limits for a Class B digital device, pursuant to part 15 of the FCC Rules (FCC CFR 47). These limits are designed to provide reasonable protection against harmful interference in a residential installation. This equipment generates, uses and can radiate radio frequency energy and, if not installed and used in accordance with the instructions, may cause harmful interference to radio communications. However, there is no guarantee that interference will not occur in a particular installation. If this equipment does cause harmful interference to radio or television reception, which can be determined by turning the equipment off and on, the user is encouraged to try to correct the interference by one or more of the following measures:

- Reorient or relocate the receiving antenna.
- Increase the separation between the equipment and the receiver
- Connect the equipment into an outlet on a circuit different from that to which the receiver is connected.
- Consult a dealer or an experienced radio/TV technician for help.



The CMOSens® SFC5500 devices fully comply with norm EN 61000-6-1 to EN 61000-6-4 (Immunity and Emission Test Series).



Sensirion AG
Laubisruetistr. 50
CH-8712 Staefa ZH
Switzerland

phone: +41 44 306 40 00
fax: +41 44 306 40 30
info@sensirion.com
www.sensirion.com

Sensirion Taiwan Co. Ltd
phone: +886 3 5506701
info@sensirion.com
www.sensirion.com

Sensirion Inc., USA
phone: +1 312 690 5858
info-us@sensirion.com
www.sensirion.com

Sensirion Japan Co. Ltd.
phone: +81 3 3444 4940
info-jp@sensirion.com
www.sensirion.com/jp

Sensirion Korea Co. Ltd.
phone: +82 31 337 7700~3
info-kr@sensirion.com
www.sensirion.com/kr

Sensirion China Co. Ltd.
phone: +86 755 8252 1501
info-cn@sensirion.com
www.sensirion.com/cn

To find your local representative, please visit
www.sensirion.com/distributors